



MeacoDry ABC Dehumidifier Instruction Manual



MeacoDry ABC 10L, 12L and 20L Dehumidifier

Please read this instruction manual before using the dehumidifier and keep safe for future reference.

Thank you for choosing Meaco, we really appreciate it.

SAFTEY INFORMATION

This dehumidifier must not be used in rooms under the following conditions:

- *Potentially explosive atmosphere*
- *Aggressive atmospheres*
- *Featuring a high concentration of solvents*
- *An extremely high ratio of dust*

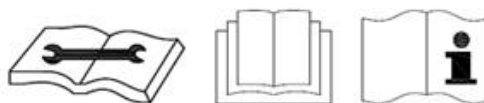

Keep Children Away: Do not allow children to play with or around this unit, which could result in injury. Be sure the unit is inaccessible to children when not attended. This appliance is not intended for use by person (including children) with reduced physical, sensory or mental capabilities, or lack of experience and knowledge, unless they have been given supervision or instruction concerning use of the appliance by a person responsible for their safety.

Keep Unit Grounded: Always operate the unit with a grounding plug and a grounded electrical outlet. A grounding plug is an essential safety feature that helps reduce the risk of shock or fire.

Protect Power Cord from Damage: Never operate a unit with a damaged power cord, as this may lead to electrical or fire hazards. If the power supply cord is damaged, it must be replaced by a cord of the same type and amperage rating.

Extension Cords: Extension cords must be grounded and able to deliver the appropriate voltages to the unit.

Handle with Care: Do not drop, throw or crash the dehumidifier. Rough treatment can damage the components or wiring and create a hazardous condition.

Run on Stable Surface: Always operate the unit on a stable, level surface, for example the floor or a strong counter, so that the dehumidifier cannot fall and cause injury.

Keep Out of Water: Never operate the unit in pooled or standing water, as this may create a risk of injury from electrical shock. Do not store or operate outdoors. If electrical wiring or components become wet, thoroughly dry them before using the unit. If in doubt do not use the dehumidifier and consult a qualified electrician or a Meaco approved engineer.

Keep Air Intakes Clear: Do not clog or block the air intakes by placing the dehumidifier too close to curtains, walls or anything that will restrict the air inlet. This may cause the unit to overheat and result in a fire or electrical hazard.

Keep Electrical Components Dry: Never allow water inside the dehumidifier's electrical components. If these areas become wet for any reason, thoroughly dry them before using the dehumidifier. If in doubt, do not use the dehumidifier and consult a qualified electrician or a Meaco approved engineer.

The operator must make the operating instruction available for the user and make sure that the user does understand the manual.



The MeacoDry ABC 10L, 12L and 20L dehumidifiers use the new R290 refrigerant gas to comply with European Environmental Directives. R290 is kinder to the environment and is part of attempts to reduce global warming as it has a low greenhouse effect (GWP).

When using the MeacoDry ABC 10L, 12L and 20L dehumidifiers you must take into account the following:

- This dehumidifier uses about 35 grams of R290 refrigerant in the 10L model, 45 grams of R290 refrigerant in the 12L model and 75 grams of R290 refrigerant in the 20L model, which is flammable. Therefore, it is part of a sealed system and must only be serviced by a trained Meaco engineer.
- Do not use or store this dehumidifier in a room smaller than 4m² to prevent a fire or explosion hazard if there is a leak of refrigerant and the gas comes into contact with an ignition source.
- Do not use in a room with any continuous sources of ignition, for example open flames, gas fires or hobs, cigarettes or any other sources of ignition.
- If the dehumidifier is installed, operated or stored in a non-ventilated area, then the room must be designed to prevent the accumulation of refrigerant leaks resulting in a risk of fire or explosion due to ignition of the refrigerant caused by electric heaters, cookers, or other sources of ignition.
- R290 refrigerant gas is odourless.
- Do not puncture either during the units working life or after. At the end of life dispose of following local recycling regulations.
- If there is any damage to the dehumidifier then do not use it and contact Meaco or your retailer.
- As with all dehumidifier, always keep upright and leave the dehumidifier standing upright for six hours before using it upon receipt.



Failure to comply with these instructions could result in fire, damage to property, serious injury or potentially death.

Individuals who operate or work on the refrigerant circuit must have the appropriate certification issued by a national accredited organisation that ensures competence in handling flammable refrigerants according to a specific evaluation recognised by national associations in the industry and compliant with the latest R290 guidance.

Servicing should only be carried out by a Meaco approved engineer using original Meaco parts to prevent damage to the unit and potential injury to the engineer.

GENERAL ADVICE

- Before putting your dehumidifier into operation for the first time, the instruction manual should be studied carefully.
- After receiving the dehumidifier, you should check the unit for any transport damage. In case of damage, you should inform the sender immediately.
- Store the dehumidifier box and packaging in a safe place – this will be required if the dehumidifier requires a service in the future. In order to save space, you can simply cut through the adhesive tape using a knife and fold up the cardboard box.
- Using a third-party switching device that turns the dehumidifier ON or OFF via the mains will invalidate the warranty as such devices damage the internal components.

DEHUMIDIFIER PRINCIPLES

This dehumidifier is designed to reduce humidity from the air in a building or part of a building. The purpose is to help dry laundry, prevent condensation, mould, musty air and other issues associated with high relative humidity.

The time necessary for the dehumidifier to dry a room and reach the desired relative humidity depends on the environmental conditions prevailing within the room. For example, the number of air changes with outside, any sources of moisture, and the room temperature can all either speed up or slow down the dehumidification process.

The dehumidifier functions according to the condensation principles with heat recovery. The fan takes the humid air from the room, in and across a filter, and then through an evaporator. Here the air is cooled below dew point, so that the water vapour of the air forms a condensate on the coils, which flows into the internal container ready to be poured away. The cooled and dried air is heated again by a condenser. By recycling the room air through the dehumidifier repeatedly, the moisture content and relative humidity of the air is reduced.

INSTALLATION AND TRANSPORTATION

For installation and transportation, the following instructions must be considered:

- Before using the dehumidifier, leave it to stand upright for six hours.
- Plug the unit directly into a wall socket and switch on using the ON/OFF button on the unit.
- Ensure there is more than 20cm of space around the unit to enable adequate air flow. The air inlet and the air outlet must not be covered whilst the dehumidifier is in operation.
- Make sure the water tank is securely in place. The unit will not switch on unless the water tank is secure.
- If you need to move the dehumidifier, it must be switched off by its ON/OFF switch on the unit. The mains plug must be removed from the socket and the water tank should be emptied.
- For transportation, the dehumidifier should be secured on a level base only and must be prevented from rolling around.
- The dehumidifier must always be transported vertically – if the dehumidifier has been in a horizontal position for any time over a few minutes, you must let it stand in the upright position for at least 30 minutes before operating. This allows the oil to drain back into the compressor.

PRODUCT IDENTIFICATION AND CONTROL PANEL (10L and 12L)

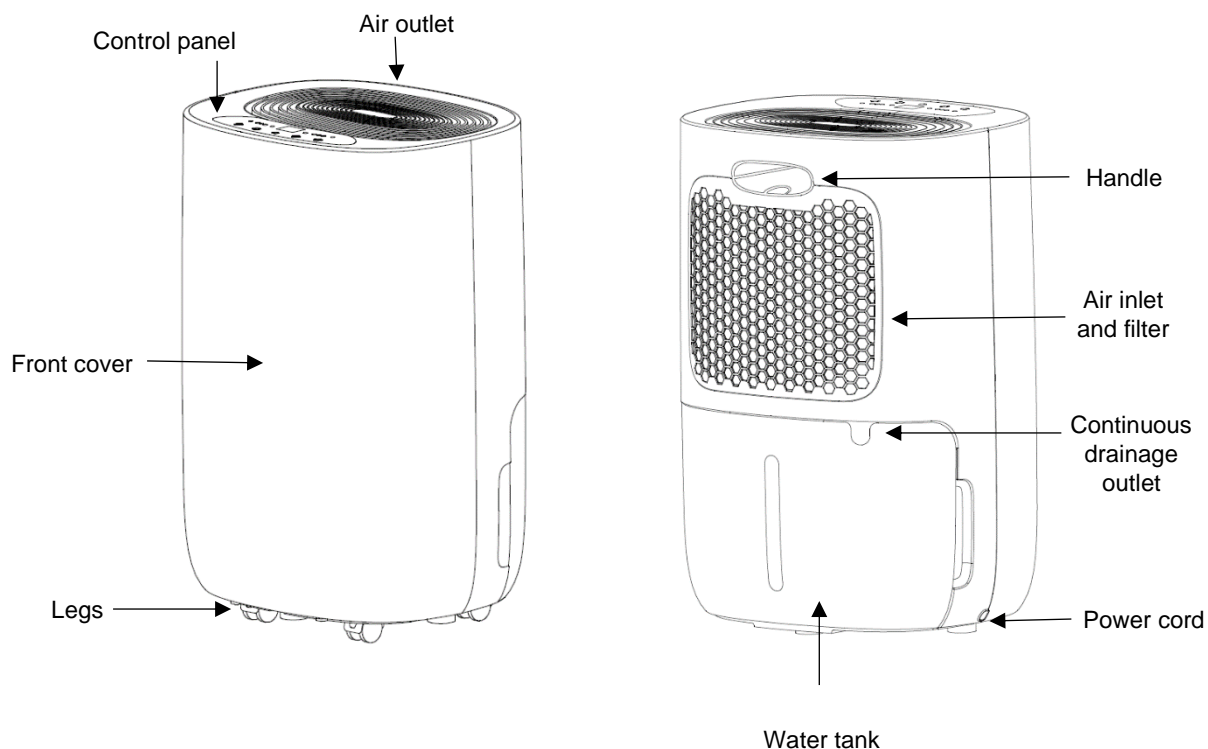

The MeacoDry ABC 10L and 12L do not come with castors. These are available to purchase separately from www.meaco.com.

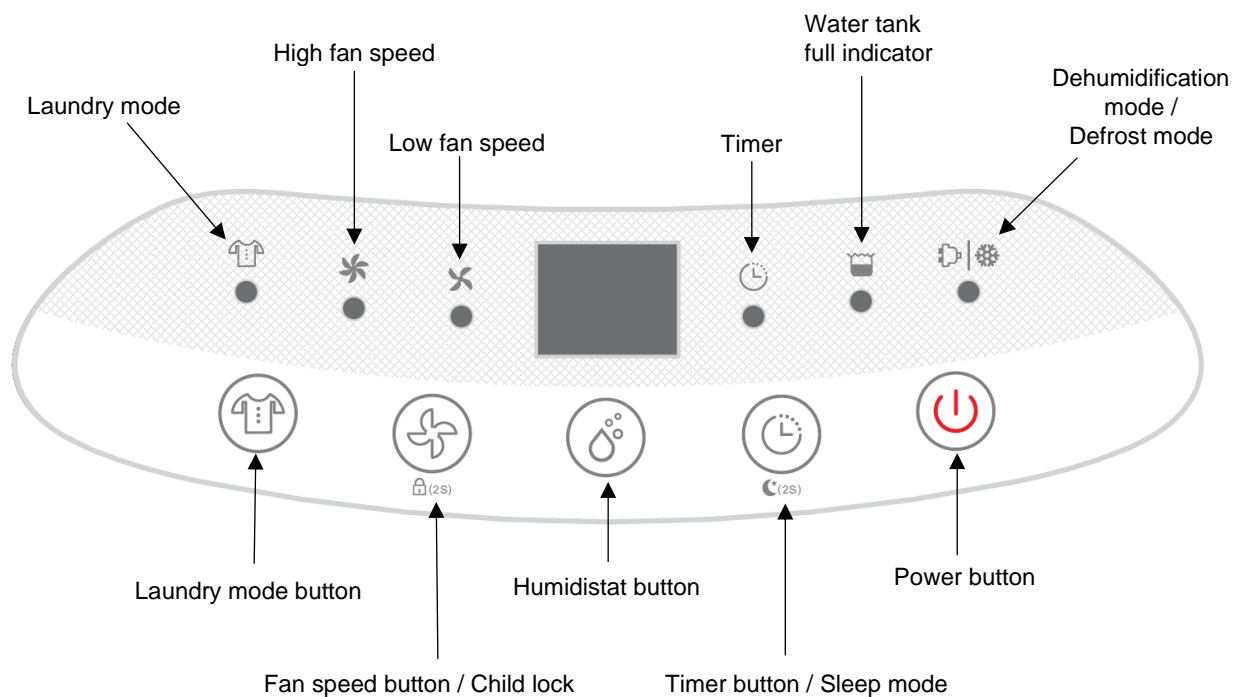

PRODUCT IDENTIFICATION AND CONTROL PANEL (20L)

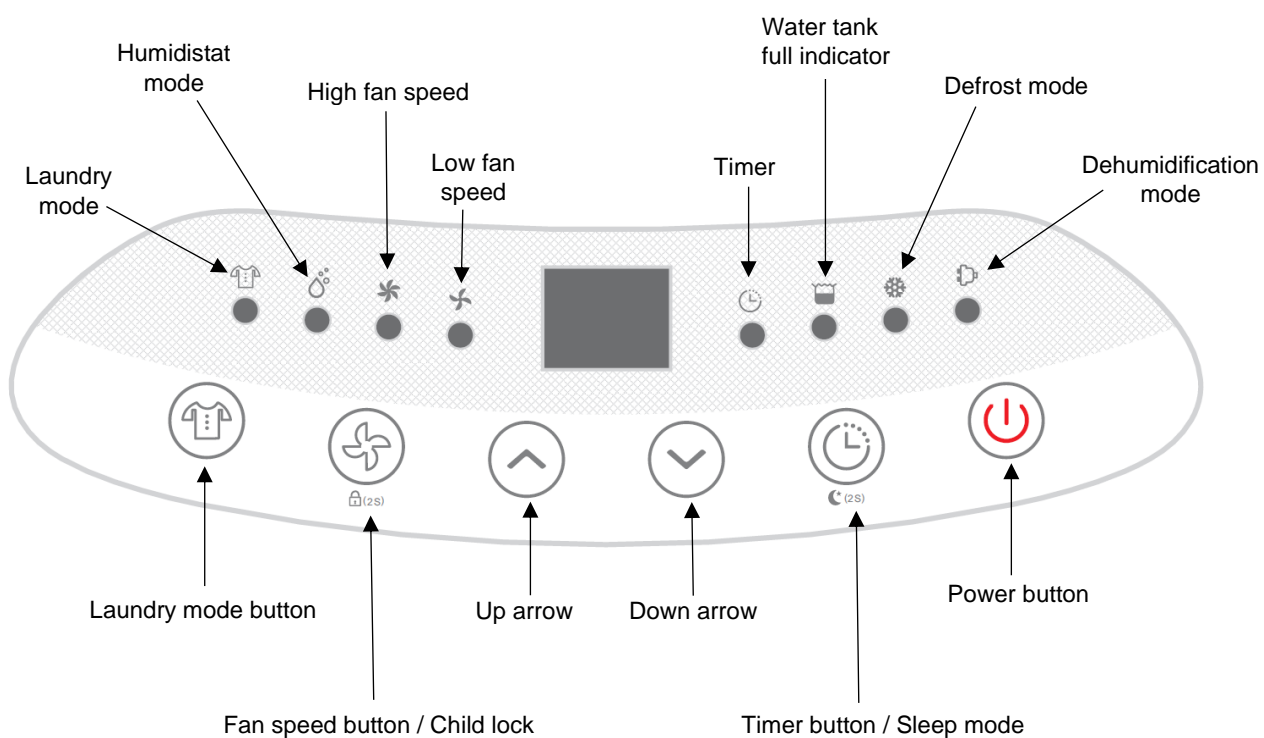
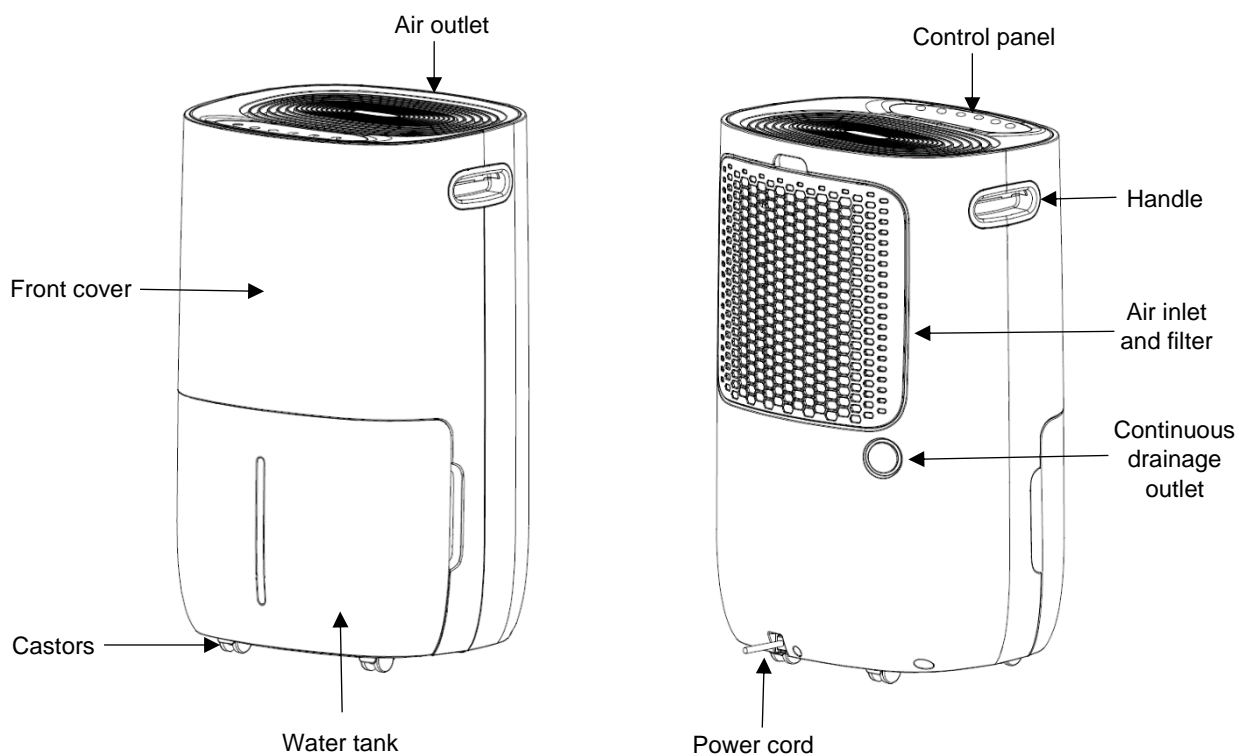

SETTINGS

POWER BUTTON



When the dehumidifier is plugged into a wall socket, the dehumidifier will bleep and the display will remain blank. Press the power button to turn the dehumidifier ON or OFF.

The buttons on the control panel are sensitive. Press the power button quickly and firmly. Do not hold the power button down.

TIMER BUTTON



The timer acts as a countdown timer. This can be used if you want the dehumidifier to run for a set number of hours and then switch off. Press the timer button until you reach the desired number of hours you want the dehumidifier to run for (it can be set between 1 and 24 hours). The set number of hours will flash 5 times and then the display will change back to the relative humidity level in the environment. This is not a daily run timer and needs to be set each time you wish to use it.

If at any point you wish to check how long is left on the timer, press the timer button once. To turn off the timer either press the timer button until you reach '00' on the display or turn the dehumidifier off and back on again using the power button.

The buttons on the control panel are sensitive. Press the timer button quickly and firmly. Do not hold the timer button down as the dehumidifier will go into sleep mode (see below).

SLEEP MODE



To enter sleep mode hold the timer button down for 2 seconds. All the indicators on the display will turn off and the dehumidifier will continue to run in low fan speed only. The dehumidifier will bleep if a button is pressed but will not bleep when the water tank is full. If you press a button once the indicators will show on the display and turn off again after 30 seconds.

To turn off sleep mode press two different buttons within 30 seconds or unplug the dehumidifier for 40 minutes.

HUMIDISTAT BUTTON



The humidistat button can be used to select a target relative humidity between 30%rh and 80%rh or CO mode. Press the humidistat button until you reach your desired target relative humidity. On the 20L model the up and down arrows can be used to scroll through the options. The dehumidifier will run until the target humidity level has been reached. If you choose CO mode, the dehumidifier will run continuously and never stop.

The dehumidifier will go through the settings in the following order: CO-30-35-40-45-50-55-60-65-70-75-80.

FAN SPEED BUTTON



Use the fan speed button to select either high or low fan speed. The LED indicators above the fan speed button indicate which speed has been selected (the LED light on the left is for high fan speed and the LED light on the right is for low fan speed).

We recommend using high fan speed when drying laundry.

The buttons on the control panel are sensitive. Press the fan speed button quickly and firmly. Do not hold the fan speed button down as the dehumidifier will turn child lock on (see below).

CHILD LOCK



To activate child lock hold the fan speed button down for two seconds. 'LC' will appear on the display for 5 seconds and then the display will change back to the relative humidity level of the environment. Whilst child lock is on, the settings cannot be changed. To deactivate child lock hold the fan speed button down for two seconds – the dehumidifier will beep once. If you are unable to remove child lock using the fan speed button, unplug the dehumidifier for 40 minutes.

LAUNDRY BUTTON



Press the laundry button once to turn laundry mode on, press the laundry button again to turn laundry mode off. The dehumidifier will run continuously in high fan speed mode for 6 hours. After 6 hours the dehumidifier will switch off until it is manually switched on again. Laundry mode can be switch off at any point by pressing the laundry button or turning the dehumidifier off using the power button. On Laundry Mode you cannot set a target humidity level.

WATER TANK FULL INDICATOR



When the water tank is full the dehumidifier will beep and then switch off. Once the water tank has been emptied and placed securely back in the dehumidifier, the dehumidifier will start to run again as per its previous settings.

DEHUMIDIFICATION MODE



The LED light under the droplet and snowflake will stay on permanently, even once the dehumidifier has reached its target humidity level. This light will be solid, it will not flash. If the light is flashing on the MeacoDry ABC 10L or 12L model, it is in defrost mode (see below).

DEFROST MODE



This dehumidifier is equipped with an automatic defrosting system. When operating in low temperatures, the surface of the evaporator will accumulate frost which effects the efficiency of the dehumidifier. When this happens, the machine will automatically go into periodic defrosting and the LED light beneath the droplet and snowflake symbol will flash. The time the unit is in defrost mode will vary. This is not a fault; it is part of the dehumidification process. It is not recommended to use the dehumidifier in temperatures below 5°C.



HUMIDISTAT MODE (MeacoDry ABC 20L only)

The humidistat mode indicator will automatically display when the dehumidifier is in humidistat mode i.e. a target humidity level has been set.

The humidistat mode indicator will turn off when the dehumidifier is in laundry mode.

READINGS ON THE DISPLAY

When the dehumidifier is switched on, the reading on the display will show the **current relative humidity level in the environment** the dehumidifier is being used in.

When the humidistat button (on the 10L and 12L model) or the down arrow (on the 20L model) is pressed once, the display will show the mode the dehumidifier is set to, for example, it will either show the **target humidity level set** or CO. We recommend setting the dehumidifier to reach a target humidity level of 50%rh or 55%rh. After two seconds the display will then revert to the current relative humidity level in the environment.

OTHER FUNCTIONS

CONTINUOUS (CO) MODE

In order to achieve this mode, keep pressing the humidistat button (on the 10L and 12L model) or the down arrow (on the 20L model) until CO appears on the display. In CO mode the dehumidifier will not stop, it will continue to dry the environment regardless of the room relative humidity. This is the recommend setting for drying your laundry.

MEMORY FUNCTION / AUTO RE-START

When the dehumidifier is switched off by the ON/OFF button, when turned back on the dehumidifier will continue to run in the same settings it was previously running on. When the dehumidifier is switched off by the mains or due to a power cut, when turned back on the dehumidifier will default to a target of 50%rh.

MEACO CONTROL LOGIC

When the room relative humidity is more than 3%rh below your target relative humidity the dehumidifier will stop drying the air, but the fan will continue to run for a few minutes. If the relative humidity is stable, then the dehumidifier will go to sleep for 30 minutes. After 30 minutes the dehumidifier will wake up and sample the air with just the fan running so that the relative humidity sensor can tell the control panel what the room relative humidity is, if the relative humidity is more than 3%rh above the set point then it will start to dehumidify again, if not then the fan will go to sleep again for another 30 minutes.

WHAT MEACO RECOMMENDS

GENERAL USE IN THE HOME

For general use we recommend setting the dehumidifier to reach a target humidity level of 50%rh or 55%rh and positioning the dehumidifier in a central position within your home, for example the landing or hallway. If you have more of a problem in one area of your house/flat, place the dehumidifier closer to that area. Leave all the interior doors open and keep the windows closed. Moisture in the air, from the entire house, will migrate towards the dehumidifier allowing the machine to reduce the relative humidity level. For best results, leave your dehumidifier running 24/7.

Please note, when you first start using your dehumidifier, you may find it will run continuously, collecting a large amount of water, or struggling to reach the target humidity level. This is completely normal. There will be a lot of excess water in the environment that the dehumidifier needs to remove, meaning it must work a lot harder. After a few weeks, the humidity level will stabilise meaning your dehumidifier will run less frequently and collect less water.

DRYING LAUNDRY

To dry laundry faster, place the laundry and the dehumidifier into as small a room as possible, with all the doors and windows closed. Position the dehumidifier so that its dry air can hit as large an area of washing as possible and position the laundry so that the air can circulate around them. Make sure water from the laundry is not able to drip onto the dehumidifier. If possible, use a pedestal fan to speed up the airflow and push more dry air across more of the laundry. Some warmth in the room will also help. Set the dehumidifier to run on CO mode and the highest fan speed.

CONTINUOUS DRAINAGE

If you wish to drain water away continuously and not empty the water tank, a hose can be attached as per the images below. Make sure the hose runs downwards, with no kinks, bends or blockages, to allow water to run out of the unit via gravity.

MEACODRY ABC 10L AND 12L DEHUMIDIFIER

In order to use continuous drainage, remove the water tank from the dehumidifier. Secure the 14mm hose onto the internal outlet pipe. Once the hose is in place, put the water tank back into the dehumidifier (for continuous drainage to work, the water tank must always be in place). There is a slot in the water tank for the continuous drainage hose to sit in.

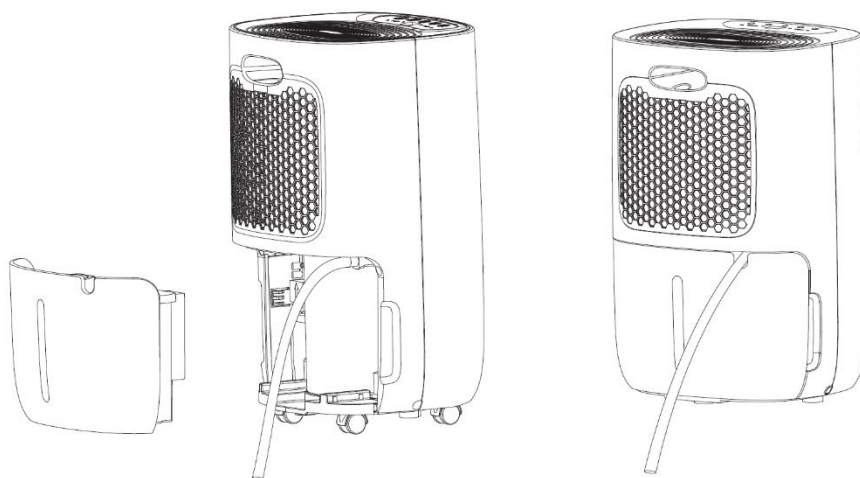

MEACODRY ABC 20L DEHUMIDIFIER

In order to use continuous drainage, take the plug off the back of the dehumidifier and push the 14mm hose through the hole securing it to the internal outlet pipe (for continuous drainage to work, the water tank must always be in place).

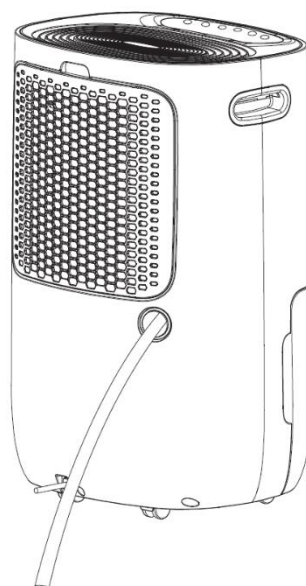

As a company we understand the urgency of Climate Change and recognise how important it is to play our part in becoming more environmentally friendly. For this reason, there is not a continuous drainage hose included in our dehumidifiers to reduce the amount of plastic waste created, as most of our customers do not use them. If you would like to use the continuous drainage option on your dehumidifier, you can either purchase a hose from our website (www.meaco.com) or use a garden hose that has an internal diameter of 14mm (MeacoDry ABC 10L, 12L and 20L).



WATER TANK

The water tank is found on the front of the unit on the 20L model and at the back of the unit on the 10L and 12L model. In order to empty the water tank, simply pull the tank out from the unit and empty the water. The lid does not need to be removed as the water can be poured out of the hole at the corner. The water collected can be used to water non-edible plants only – do not consume.

Please note, located inside the water tank is a float. It is essential this float is NOT removed from the water tank. The float measures the level of water in the water tank and triggers the sensor to turn the dehumidifier off when the water tank is full.

MEACODRY ABC 10L AND 12L DEHUMIDIFIER

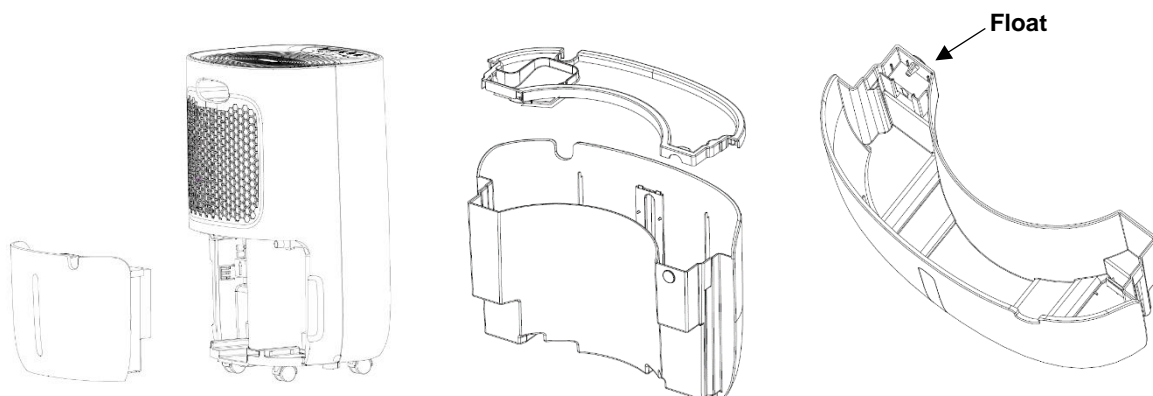

MEACODRY ABC 20L DEHUMIDIFIER

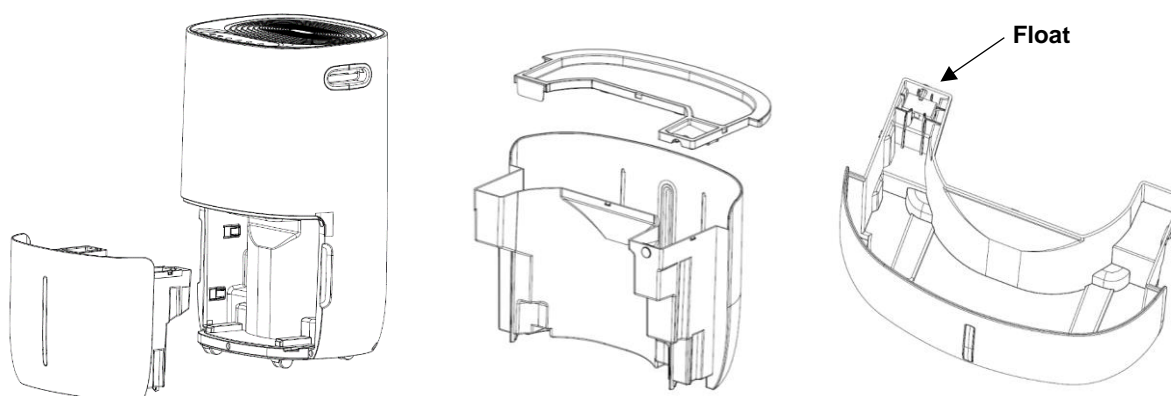

MAINTENANCE

Always turn off the power and disconnect the main cable before performing maintenance procedures.

INSPECT ELECTRICAL SYSTEM

- Inspect the electrical cord for damage at regular intervals.

CLEANING THE EXTERIOR

- Clean the exterior with a soft, dry cloth. If the device is extremely dirty, use a mild cleaning agent or wipe the dehumidifier with a slightly damp cloth. Never spray the device with water.

CLEANING THE FILTER

The filter is a life-long filter which should not need to be replaced (other than for wear and tear reasons). When used regularly, the filter may become clogged with dust and dirt particles. The filter must be cleaned a minimum of every two weeks (not doing so could invalidate the units' warranty). Please use the following steps:

- Remove the combined filter and filter case.
- Clean both sides of the filter with the end of a Hoover or soapy water no hotter than 40°C. Rinse and dry completely before inserting back into the dehumidifier.

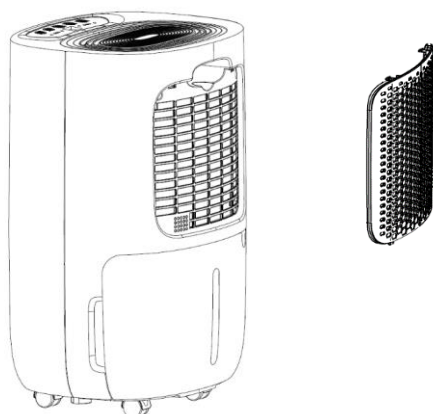

MeacoDry ABC 10L and 12L – the filter and filter case are combined; they cannot be separated.

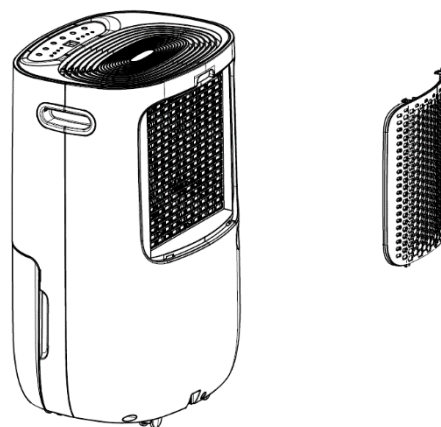

MeacoDry ABC 20L – the filter and filter case are combined; they cannot be separated.

STORAGE

If the machine will not be used for a long period of time, take the following steps:

1. Remove the plug from the socket and empty the water tank. Allow the water tank and the dehumidifier to dry completely, this can take a couple of days.
2. Clean the filter and store the device in a dust-free location away from direct sunlight, preferably covered with a sheet of plastic.

SPECIFICATIONS

		MeacoDry ABC 10L	MeacoDry ABC 12L	MeacoDry ABC 20L
Extraction Rate	at 30°C and 80%rh	10 litres per day	12 litres per day	20 litres per day
	at 27°C and 60%rh	6 litres per day	7.5 litres per day	11.5 litres per day
Variable humidistat		Yes between 30%rh and 80%rh	Yes between 30%rh and 80%rh	Yes between 30%rh and 80%rh
Air flow (nominal)		105m ³ /hour	105m ³ /hour	145m ³ /hour
Noise level at one metre		Maximum 40dB(A)	Maximum 40dB(A)	Maximum 44dB(A)
Power Supply		230V, 50Hz	230V, 50Hz	230V, 50Hz
Rated power consumption		165W	165W	255W
Rated current		1.00A	1.00A	1.55A
Filter		Yes	Yes	Yes
Auto-restart		Yes	Yes	Yes
Fan speeds		Two	Two	Two
Operating temperatures		+5 °C / +35°C	+5 °C / +35°C	+5 °C / +35°C
Refrigerant		R290 / 35g	R290 / 45g	R290 / 75g
Tank		2.6 litres	2.6 litres	5.0 litres
Dimensions (HWD)		300 x 250 x 463 mm	300 x 250 x 463 mm	540 x 335 x 285mm
Weight		10.1Kgs	10.4Kgs	15.2Kgs

TROUBLE SHOOTING

TROUBLE	CAUSE	SOLUTION
The unit does not work	The power is not connected	Insert the plug into the wall outlet
The unit beeps but there is no power	The power button is being held down for too long	Press the power button quickly and firmly
'LC' has appeared on the display	The dehumidifier has been put into Child Lock mode	This is not a fault. Hold the fan speed button down for two seconds to deactivate child lock (see page 8)
The unit is running but there are no lights on the display	The unit is in sleep mode	To turn sleep mode off press two different buttons with 30 seconds or unplug the dehumidifier for 40 mins (see page 7)
The unit does not collect water	The water tank is full	Empty the water tank and reinsert
	The water tank has not been inserted correctly	Make sure the water tank is securely in place
	The filter is blocked	Clean the filter (see page 13)
	The temperature or the relative humidity in the room where the unit is operating is too low	It is normal that the unit does not collect water in these conditions
	The set target humidity level is too high	Select a new, lower, target humidity level
The unit works but reduces the humidity level insufficiently / there is little water in the water tank	The space is too large	Allow the unit to run for longer or consider a larger machine
	There is too much ventilation	Reduce ventilation e.g. close windows and shut external doors
	The filter is blocked and reducing the air flow into the dehumidifier	Clean the filter (see page 13)

The windows were clear and now condensation has returned	The outside air temperature has dropped and the windows are colder	Set the unit to reach a lower target humidity level and run it 24 hours a day
I cannot remove the condensation from my windows, even in CO mode	The surface temperature of the windows is too low for a dehumidifier to prevent condensation. This is common with single glazed windows and when the outside air temperature drops below freezing	Keep running the unit on CO mode for 24 hours a day, when the air temperature outside increases the windows should clear of condensation
The unit is blowing out warm air	The dried air is passed over heating coils before it is blown into the room as part of the dehumidification process	This is normal, the dehumidifier is not an air cooler
The unit is blowing out cold air	The unit does not cool the air however the air might feel cooler because it is moving – this is the same as the air from a fan	The room temperature will not be reduced by the unit and it is not cooling the air
The display is not showing the target humidity level	The display shows the relative humidity level of the environment the unit is used in, not the target humidity level	Press the humidistat button (on the 10L and 12L) or the down arrow (on the 20L) once to see the target humidity level
I keep my finger on the button but the reading on the display does not change	The buttons only move one step at a time	Press the button, lift your finger and then press the button again to move through the settings
The unit is noisy	The filter is blocked	Clean the filter (see page 13)
	The unit is being used on an uneven surface	Move the unit to an even surface – the unit will be noisier on wooden floors than carpet
E1 Error Code	Coil temperature error. The unit still dehumidifies but is in defrost mode only.	Please contact Meaco.
E2 Error Code	The humidity sensor is broken. The unit still dehumidifies but in continuous mode only.	Please contact Meaco.

WARRANTY AND CUSTOMER SERVICE

There is a two-year manufacturer's warranty on your dehumidifier from the date of purchase. Please register your purchase at <https://www.meaco.com/pages/register-your-warranty> - as a thank you, you will be entered into our monthly free prize draw to help support the David Shepard Wildlife Foundation. Registering also allows us to keep you update with any important developments concerning your product.

Within the two-year manufacturer's warranty, all manufacturing defects will be repaired free of charge (excluding damage to the units' filter and water tank which can be subject to wear and tear).

The following applies:

1. Any repairs or replacement of components during the warranty period will not result in an extension of the warranty period.
2. The warranty will expire if any alterations have been made, not genuine components have been fitted or if the dehumidifier has been repaired by a third party.
3. Components subject to normal wear and tear are not covered by the warranty.
4. The warranty is only valid on presentation of the original, unaltered, and date-stamped purchased receipt.
5. The warranty does not cover damage caused by actions that deviate from those as described in the user's manual or by neglect.
6. The warranty does not cover faults caused by dirt or by third-party products.
7. The warranty does not cover accidental damage.
8. All claims for compensation, including consequential damage, will not be entertained.
9. Using a third-party switching device that turns the dehumidifier on or off via the mains will invalidate the warranty.

For the full list of the warranty terms and conditions please visit:
<https://www.meaco.com/pages/warranty-terms>.

To prevent unnecessary expenses, we recommend that you always carefully read the user's manual first. If this does not provide a solution, please call Meaco and we will be happy to help.

This dehumidifier has been imported into the UK and EU by:

*Meaco (UK) Limited
Meaco House
Parklands, Railton Road
Guildford, GU2 9JX*

*Telephone: 01483 234900
Email: customerservice@meaco.com
Website: www.meaco.com*

Please record, for future reference, your date of purchase and where you bought the dehumidifier from here.

Date of purchase:

Purchased from www.meaco.com (if not, then please record the supplier's name below).

Suppliers name:

If your dehumidifier develops a fault at any time, please contact us and we will always try and help you as best we can. Please keep hold of the original box and packaging your unit arrived in just in case we need to collect the dehumidifier from you for a repair/service in the future.



The marking below indicates that this product should not be disposed with other household wastes throughout the UK and EU. To prevent possible harm to the environment or human health from uncontrolled waste disposal, recycle it responsibly to promote the sustainable reuse of material resources. To return your used device, please use the return and collection systems or contact the retailer where the product was purchased. They can take this product for environmental safe recycling.

