



Meaco DD8L desiccant dehumidifier Instruction Manual



Meaco DD8L Desiccant Dehumidifier
January 2013 edition

Please read this instruction manual before using the dehumidifier and keep safe for future reference.

Thank you for choosing Meaco, we really do appreciate it.

Extend your warranty on page 17

PRODUCT DESCRIPTION

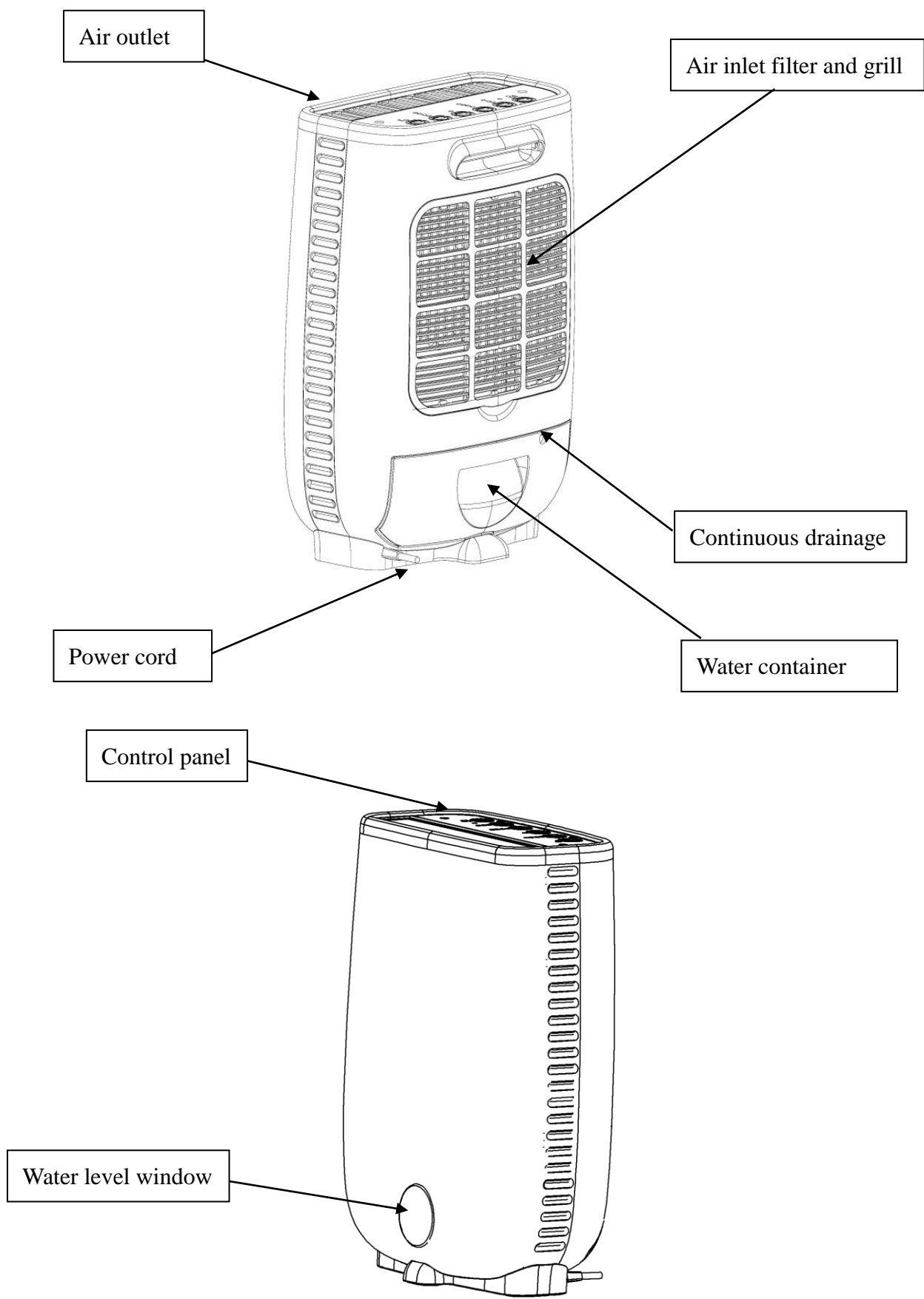

SAFETY INSTRUCTIONS

PLEASE READ ALL INSTRUCTIONS CAREFULLY BEFORE OPERATING.

In case of a failure whilst under warranty we will collect the dehumidifier from you for repair/replacement, therefore please save the packaging and keep it safe away from children. When you do dispose of the packaging please recycle.

WARNING - This appliance is intended for use in a domestic environment only. Any other use is not recommended by the manufacturer and may cause fire, electrical shocks or other injury to person or property. When using electrical appliances, basic safety precautions should always be followed:

1. Do not operate the unit with a damaged cord or plug, after it malfunctions or has been dropped or damaged in any way. Return to an authorized service facility for examination and repair.
2. This unit should always be kept in an upright position to avoid any damage. Locate the unit on a flat stable surface.
3. Check the household voltage to ensure it matches the units rated specification before operating.
4. Operate this unit in an ambient temperature between 1°C and 37°C.
5. Ensure that the air inlets and outlets are not blocked or covered.
6. Do not place the unit too close to curtains or other objects - min 30cm.
7. When using the "Laundry  " to speed up the drying of wet clothes in the room, keep the clothing at a safe distance from the unit to prevent water from dropping onto the unit.
8. Never place anything on top of the unit and do not cover with any kind of material while in use.
9. This product is intended for domestic and light office use ONLY and not for commercial, industrial or outdoor use.
10. To protect against electrical shocks, do not immerse unit, plug or cord in water, or spray with liquids.
11. Never unplug the power cord without press the "Power" key to off first, as this could damage the unit. Never unplug the dehumidifier before the fan has stopped blowing.
12. Always unplug the unit when not in use or moving location. To disconnect from the power supply, grip the plug and pull from the power socket. Never pull by the cord.
13. Always empty the water tank before storing the unit away.
14. Close supervision is necessary when any appliance is used by or near children and pets.
15. Do not run power cord under carpeting, or cover with rugs or runners. Arrange the cord away from areas where it may be tripped over.
16. Never operate or store the unit in direct sunlight.
17. To repair the unit, take it to a qualified service engineer. Repairs carried out by unqualified people may cause damage to the unit or injury to persons or property and void the warranty.
18. Where possible, avoid the use of an extension cable as they may overheat and cause a risk of fire. Only use an extension cord after ensuring it is in perfect condition. Extension leads can also cause

voltage drop which will affect the dehumidifier. This is more likely when being used in garages and out buildings.

19. Do not use the unit without the air filter as this will allow dirt to gather inside the dehumidifier and could invalidate the warranty.

20. Check the filter regularly in order to keep it clean as per page 13. A dirty filter will restrict the air flow into the machine which will increase the resistance on the fan and could result in damage and might invalidate the warranty.

BS PLUG WIRING

Wiring Instructions: Should it be necessary to change the plug please note the wires in the mains lead are coloured in accordance with the following code :

BLUE - NEUTRAL

BROWN - LIVE

GREEN AND YELLOW – EARTH

As the colours of the wires in the mains lead of this appliance may not correspond with the coloured markings identifying the terminals in your plug, proceed as follows:

1. The **BLUE** wire is the **NEUTRAL** and must be connected to the terminal which is marked with the letter **N** or coloured **BLACK**.
2. The **BROWN** wire is the **LIVE** and must be connected to the terminal which is marked with the letter **L** or coloured **RED**.
3. The **GREEN/YELLOW** is the **EARTH** and must be connected to the terminal which is marked with the letter **E** or or coloured **GREEN OR GREEN/YELLOW**.
4. Always ensure that the cord grip is positioned and fastened correctly.

If a 13A (BS 1362) fused plug is used it must be fitted with a 13A fuse. If in doubt consult a qualified electrician.





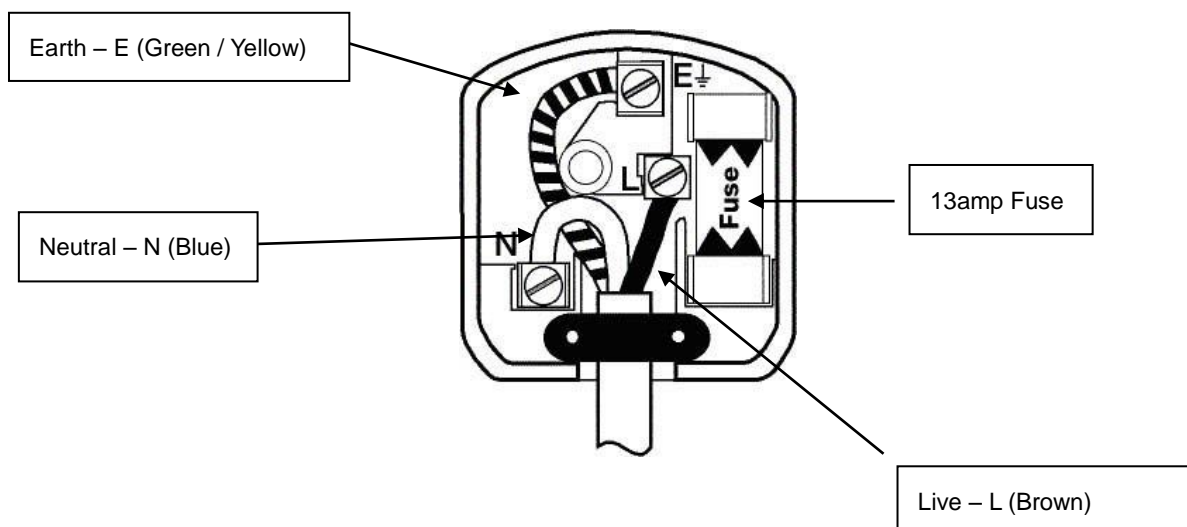

Wiring for a 13Amp Plug (BS1362)

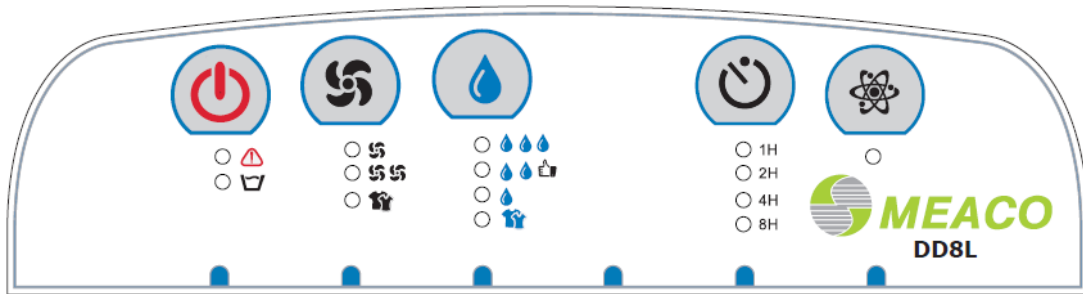
Please note. The Earth Terminal is marked with the letter **E** or Earth Symbol.



THE CONTROL PANEL



- Power**  - Lights up when there is power to the dehumidifier, the unit beeps three times when it is turned on.
- Tank Full**  - Lights up when the internal tank is full of water and needs to be emptied or when the tank is incorrectly fitted.
- Fault**  - Lights up when a fault is detected. Most common would be the air inlet being blocked leading to the dehumidifier over heating internally. Clean the filter; make sure that the dehumidifier is not next to a heat source (i.e. a radiator) and restart the dehumidifier after ten minutes.
- Fan**  - Press the Fan button to toggle between the three fan speeds, low, medium and high. In High fan speed the machine defaults to a Continuous running mode. Water extraction will increase in medium and high fan speeds because the regeneration heater will switch to maximum power (this increases the running wattage of the dehumidifier as well and the amount of heat delivered to the room).
- Maximum** * -Runs the dehumidifier until a relative humidity of 40%rh has been reached the dehumidifier then it goes into the 30 minute cycle as detailed in bold below.
- Normal** * -Aims to achieve a relative humidity of 50%rh which will be fine for most household applications. To prevent condensation on single glazed windows or when the outside temperature drops below about 5°C you should use Maximum instead of Normal. Once 50% has been reached the dehumidifier then goes into the 30 minute cycle as detailed in bold below.
- Minimum** * - Controls the relative humidity to 60%rh which will prevent mould from growing in the immediate vicinity of the dehumidifier but not throughout a whole house. Once 60%rh has been reached the dehumidifier then goes into the 30 minute cycle as detailed in bold below.

Laundry * - Use this mode when you want to dry washing. For optimum performance place the dehumidifier in as small a room as possible with the door and windows closed. The dehumidifier will dry continuously to try to achieve a relative humidity of about 35%rh which will help to dry the washing efficiently.

Take care to ensure that the dehumidifier does not become covered by the washing and that no water drips onto the dehumidifier.

Timer  - Using this button turns the machine off after either 1, 2, 4 or 8 hours of use. This setting is useful for drying washing in a set time.

Ion  - Turns the ioniser function on or off. An ioniser delivers negative ions into the air, these will attach themselves to positive ions (dust for example). This action makes the new particle heavier and the particle will fall to ground and will either be captured by the filter or will settle on the floor ready to be vacuumed up. The advantage of this is that you are less likely to inhale the particle which is good news if you are allergic to certain pollutants and the air will be cleaner.

***In the three modes that are controlled by the relative humidity stat (Minimum/Normal and Maximum) when the target relative humidity has been reached the dehumidifier will stop drying the air but the fan will continue to run for 5 more minutes. When this happens no more water will be collected, this is perfectly normal. The fan then goes to sleep for 30 minutes after which it will wake up and sample the air so that the dehumidifier knows when to start collecting water again, but if the relative humidity remains below the target then the fan will go to sleep again for another 30 minutes and so on. When the relative humidity rises again the dehumidifier will automatically start to collect water again. Although the Laundry mode aims for a lower relative humidity it will reach a point after which there will be no more water to collect because it will not over dry the air below a point at which the air will become uncomfortable (around 35%rh).**

If one of the following events happens then the control panel will lock up and the fan light will flash.

- Temperature below 10°C
- Temperature above 40°C
- Relative humidity below 40%rh
- Machine has been working hard and needs to cool down internally

If you find that this happens and none of the buttons on the control respond, **then do not worry, this is normal** and the dehumidifier is still drying the air as per the setting you left it in. The control panel will start to work again when the conditions allow.

UNDERSTANDING AND USING A DEHUMIDIFIER

How does a dehumidifier work?

There are four types of dehumidifier sold to the domestic market in the UK - Compressor, desiccant (this dehumidifier), peltier and silica gel.

A desiccant based dehumidifier draws the air in from the room over a filter and passes it over a rotating wheel that is full of a material called Zeolite which absorbs the excess water out of the air. The wheel is now saturated and needs to be regenerated. A heater in the base of the dehumidifier and a second fan work together to regenerate the desiccant by drying it out. The desiccant is now ready to dry again and the warm, wet air from the wheel goes into the plastic condenser tubes and is cooled by the air coming in from the room which allows the moisture to condensate and the water drips into the internal tank. The heat used during the drying process is mixed with the dry air to ensure that the air that comes out of the dehumidifier is not just drier but 10-12°C warmer than the air that came in.

Why does water appear on my windows/cupboards/walls?

It is a basic law of physics that if the surface is cold enough and if there is enough water vapour in the air then it will condense. This means in the case of windows whether they are double-glazed or not that if the windows are cold enough and there is enough moisture in the air then condensation will occur.

Where does this water come from?

We all produce water by drying clothes indoors, the boiling of vegetables, showering, rain, calor gas heating and making cups of tea all produces moisture. It is just an on-going process that never stops.

Can I just get rid of it by opening my windows?

This is fine on a nice summer's day but in winter opening your windows will just result in you losing the heat from your central heating and creating draughts. This is a waste of money and if it is raining will just let more moisture in. You might as well just throw fivers out of the window.

Will a dehumidifier do the whole house?

A dehumidifier creates a volume of dry air in as large a space as its fan can effect (this dehumidifier can control up to a small 5 bedroom house). After that it will be helped by the fact that damp air will always migrate to dry places. As long as you leave all of the internal doors open a correctly sized dehumidifier will prevent condensation and mould from appearing around the whole house.

What about the black spots of mould on my window and bathroom sealant?

Mould occurs around 68% humidity, condensation occurs at 100%. As you can see from this you can have mould but still have clear windows. A dehumidifier will prevent the mould from getting any worse and once you have cleaned the mould away, it will stop it from coming back.

UNDERSTANDING AND USING A DEHUMIDIFIER

Do I put it in the worst room?

You can if you like put it in the main problem area to start with and then move it somewhere more convenient when you feel that the problem is under control. If it is just condensation on the windows that you are worried about a dehumidifier in a central position, for example the bottom of the stairs, will cure the problem in the whole house.

Does the Zeolite need replacing?

No the Zeolite is regenerated within the dehumidifier and will last for many years without the need for replacement.

Are they expensive to run?

A dehumidifier costs about 3-7p an hour to run depending on how you use it, which model you have and how damp your space is. You will find that the dehumidifier will work hard for about a month after you have bought it and then it will start to settle down. You should take into consideration the fact that the dehumidifier will not run all the time, as it will be controlled via its humidistat. Secondly it is very expensive to heat a damp house and you will see a reduction in your central heating bill when you start to use your dehumidifier.

What is the humidistat?

Just as you have a thermostat that you set on your central heating you have a humidistat on your dehumidifier. This will allow the dehumidifier to turn off and on as required without you having to worry about it.





Should I turn the dehumidifier on for just a few hours a day?

No just let the dehumidifier's humidistat decide when to dehumidify and when to run in fan only mode.

Will they help with allergies?

A dehumidifier will reduce the relative humidity in the house, which will prevent dust mites and other pests from breeding and mould from growing and spreading. In this way a dehumidifier can help with allergies.

DEHUMIDIFIER SETUP AND USE

- Place the dehumidifier in an upright position on a stable, flat surface.
- Please ensure the unit is a safe distance away from a wall or furniture.
- Please keep clothes at a safe distance of 30cm away from the air inlet or outlet to prevent water from dripping into the unit.
- Ensure the tank is correctly fitted, if the tank is full or is not in place, the “Empty Tank”  light comes on, an alarm will sound and the dehumidifier will turn off.
- Press the Power button , you should hear some bleeps.
- Select the Mode that you want to use the dehumidifier in, for most applications this will be the “Normal”  mode.
- To turn off press the Power button  again.

Where to position the dehumidifier

- For best results position the dehumidifier somewhere central like a landing or a hallway. As long as the internal doors are open the moisture will migrate naturally towards the dehumidifier to be processed.
- To dry washing it is best to put the dehumidifier into a small room with some heating on. Close the door and windows and use the dehumidifier in “Laundry”  mode. Hang the clothes so that they are not touching each other and so that air can circulate between the clothes. Ensure that water does not drip onto the dehumidifier.

Smell coming from the dehumidifier

When you first use the dehumidifier and periodically afterwards you might notice a smell coming from the dehumidifier. This is caused by the Zeolite desiccant material and is not a sign that the dehumidifier is faulty, nor is it harmful to humans or pets. The smell occurs because the Zeolite absorbs odours from items like cigarettes, cosmetics, hair sprays, building materials and new furniture and then when the desiccant is heated the smell is discharged into the room. This smell has been described as being like a burning smell or a sour smell. It is normal, will not last long and is not a sign of a fault. You can clear it by running the dehumidifier in a separate space like a garage or if it is dry – outside.

Amount of water collected

- When you first use your dehumidifier it will work harder to reduce the room humidity down to 50%rh (in “Normal” mode). This is the time when it will produce the most water and need emptying most frequently. As the room becomes dryer the dehumidifier collects less water and takes longer to fill the tank, this is perfectly normal. When the target relative humidity has been reached the dehumidifier will stop collecting water, again this is normal.
- If you find that you still have condensation on your windows or you need to dry the air further then use the “Maximum” mode. This might well be necessary if you have single glazed windows or if the outside air

temperature drops towards freezing.

- In the three modes that are controlled by the relative humidity stat (Maximum/Normal/Minimum) when the target relative humidity has been reached the dehumidifier will stop drying the air and will then run the fan for 5 minutes to make sure that the relative humidity is stable. When this happens no more water will be collected, this is perfectly normal. The fan then goes to sleep for 30 minutes after which it will wake up and sample the air so that the dehumidifier knows when to start collecting water again, but if the relative humidity remains below the target then the fan will go to sleep again for another 30 minutes. When the relative humidity rises again the dehumidifier will automatically start to collect water again.
- Although the Laundry mode  aims for a lower relative humidity it will reach a point after which there will be no more water to collect because it will not over dry the air below a point at which the air will become uncomfortable.

To operate safely

- Do not insert small objects into the unit or this will damage it and cause a hazard.
- Do not remove the tank when the dehumidifier is running or water may leak.
- Minimum operating condition 1°C at 40%rh relative humidity.



ATTENTION !

- Never use the device with a damaged power cord, plug, cabinet or control panel. Never trap the power cord or allow it to come into contact with sharp edges.
- Failing to follow the instructions may lead to the guarantee becoming void.

EMPTYING THE WATER

Continuous Drainage

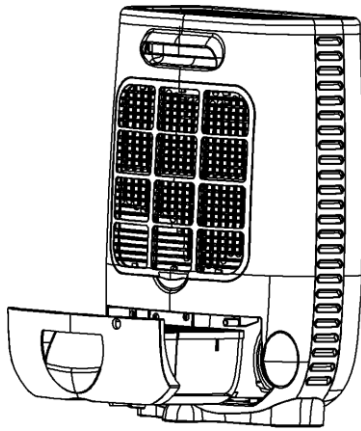

When the water container is full:

An alarm signal will sound

The Empty Tank LED will flash 

The dehumidifier will stop automatically.

Empty the water container and replace it in the correct position.

The dehumidifier will start to work again.

If the “Empty tank” light stays on and the unit does not start up then the tank is not correctly fitted.

Continuous Drainage

It is possible to connect the drainage hose (included in the box) to the dehumidifier for permanent water drainage. Simply connect the hose to the drain spout and ensure that the end of the hose is lower than the drain opening, otherwise the water will not drain and flooding may occur.

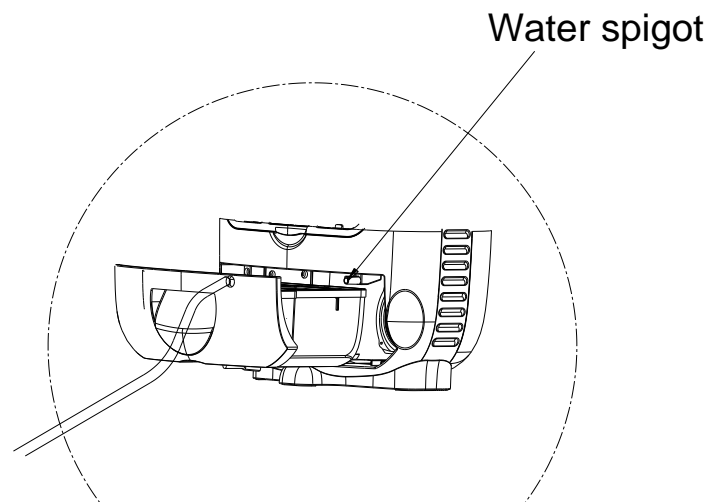

If you find that the water does not flow down the hose then check that it is running downhill, is not kinked, all excess tube has been cut off and is not blocked. If the water still does not flow then make a 4mm hole, 30mm from the spout in the top of the hose. This will balance out the air pressure and allow the water to flow.

When you no longer wish to use the permanent water drainage, disconnect the drainage tube from the

device. Ensure that the water container is positioned correctly.

CLEANING

Switch the dehumidifier off and remove the plug from the socket before cleaning.

The exterior

Clean the exterior with a soft, dry cloth. If the device is extremely dirty, use a mild cleaning agent. Wipe the dehumidifier with a slightly damp cloth. Never spray the device with water.

The air filter

When used regularly, the filter may become clogged with dust and particles. Therefore the filter should be cleaned at least every two weeks. Follow these steps:

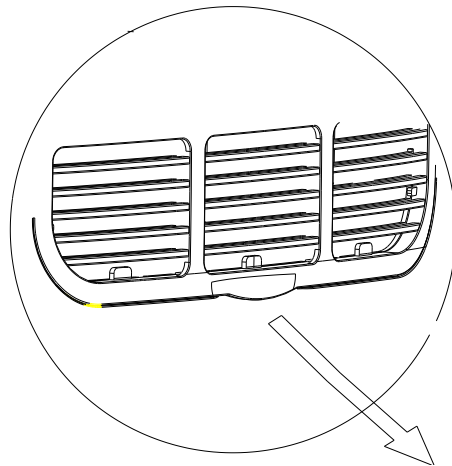

1. Remove the filter.
2. Clean the filter with a vacuum cleaner and not with water as this will damage the anti-bacterial properties of the filter.



Never use the device without the air filter.

STORAGE

Storage

If the machine will not be used for a long period of time, take the following steps:

1. Remove the plug from the socket and empty the container. Allow the container and the dehumidifier to dry completely.
2. Clean the air filter.
3. Store the device in a dust-free location away from direct sunlight, preferably covered with a sheet of plastic.

TROUBLESHOOTING

Check the following before contacting technical support:

Problem	Cause	Solution
The unit does not work.	The power is not connected.	Insert the plug into the wall outlet.
The device does not dehumidify.	The water container is full.	Remove the water from the container.
	The water container has not been replaced correctly.	Place the water container in the correct position.
	The air filter is clogged.	Clean the air filter.
	The temperature in the room where the dehumidifier is operating is too low.	The machine does not dehumidify below 1°C, it is highly unlikely at that temperature that there is any moisture to remove anyway.
	The relative humidity in the room where the dehumidifier is operating is too low.	The dehumidifier dries down to the target relative humidity set and then goes into fan only mode until the relative humidity goes above the set point again.
The dehumidifier works, but reduces the relative humidity insufficiently/there is little water in the water tank.	The house is too large. This dehumidifier can dry up to about a small five bedroom house.	We recommend using a dehumidifier with a greater capacity.
	There are too many sources of moisture. Bathing, washing, drying clothes and cooking all puts moisture into the air. Calor gas heating can add too much moisture into the air for a dehumidifier.	We recommend using a dehumidifier with a greater capacity. Consider using a different heat source to a calor gas heater.
	There is too much ventilation.	Reduce ventilation (e.g. close windows and shut doors.)
	The air filter is blocked and the reduce air flow is effecting performance.	Clean the air filter.
The windows were clear and now condensation has returned.	The outside air temperature has dropped and the windows are colder.	Use the dehumidifier on Maximum and run it 24 hours a day.
I cannot remove the condensation from my windows, even in Maximum mode.	The surface temperature of the windows is too low for a dehumidifier to prevent condensation. Common with single glazed windows and when the outside air temperature drops below freezing.	Keep running the dehumidifier on Maximum 24 hours a day and when the air temperature outside increases the windows should clear of condensation.
Dehumidifier is blowing out warm air.	The dried air is past over a heating element before it is blown into the room as part of the	This is normal, a dehumidifier is not an air cooler.

Problem	Cause	Solution
	dehumidification process.	
Knocking noise coming from the dehumidifier	Motor that rotates the desiccant wheel is low on lubrication.	Run the dehumidifier in Laundry mode for two days to increase the lubrication, if fault persists then call Meaco.
Alarm light on continuously	Restricted airflow to the dehumidifier or temperature below freezing.	Clean the filter and make sure that the unit is more than 30cm from a wall. If the temperature is below freezing then use the dehumidifier when the space warms up again.
Alarm light flashing	Restricted airflow to the dehumidifier.	Clean the filter and make sure that the unit is more than 30cm from a wall.
Water not draining down the hose	Hose is fitted for continuous drainage but the water still goes into the tank.	Negative air pressure in the room is pulling the water back into the dehumidifier overflow. Insert a 4mm hole into the top of the tube 30mm down from the spout. This will introduce air into the tube and balance out the air pressure.
Dehumidifier leaks water onto the floor	Usually means that the dehumidifier is not on a level surface or that the filter has not been cleaned often enough and dirt has fallen into the dehumidifier.	You can also check that the water bucket is not cracked by filling it with water and placing it on kitchen paper on the kitchen side.
Machine not switching off and on in the usual 30 minute pattern	Temperature and relative humidity sensor that reads the room reading is unable to read the correct readings.	Clean the filter and blow the air sensor with a hair dryer on fast setting to clear the sensor of dirt. Unplug the dehumidifier for 10 minutes to reset it's circuits and then turn back on.
Unit only works in Laundry mode and Laundry light stays on or flashes.	If the humidity sensor is faulty then the dehumidifier will only run in Laundry mode.	Try clearing the sensor as per above line, if that fails then call Meaco for a repair.
Medium fan speed light flashes	None of the buttons work.	This is normal and the unit is functioning ok. The unit will return to normal operation when conditions allow. More details below.

If one of the following events happens then the control panel will lock up and the fan light will flash.

- Temperature below 10°C
- Temperature above 40°C
- Relative humidity below 40%rh
- Machine has been working hard and needs to cool down internally.

If you find that this happens and none of the buttons on the control respond, then do not worry, this is normal and the dehumidifier is still drying the air as per the setting you left it in. The control panel will start to work again when the

conditions allow.

CONDITIONS OF WARRANTY

There is a one year warranty on your dehumidifier from the date of purchase.

All material or manufacturing defects will be repaired free of charge.

The following applies:

- Any repairs or replacement of components during the warranty period will not result in an extension of the warranty period.
- The warranty will expire if any alterations have been made to the dehumidifier, if third party components have been fitted or if the dehumidifier has been repaired by a third party.
- Components subject to normal wear and tear, such as the air filter, are not covered by the warranty.
- The warranty is only valid on presentation of the original, unaltered, and date-stamped purchase receipt.
- The warranty does not cover damage caused by actions that deviate from those as described in the user's manual or by neglect.
- All claims for compensation, including consequential damage, will not be entertained.
- The warranty can be invalidated if the dehumidifier is found to be dirty or if components inside are clogged with dirt.

To prevent unnecessary expenses, we recommend that you always carefully read the user's manual first. If this does not provide a solution, then call Meaco (U.K.) Limited on freecall 0500 418458 between Monday to Friday 9am to 5pm.

This appliance is not intended for use by person (including children) with reduced physical, sensory or mental capabilities, or lack of experience and knowledge, unless they have been given supervision or instruction concerning use of the appliance by a person responsible for their safety.

Children should be supervised to ensure that they do not play with the appliance.

You can extend your warranty from the standard one year up to a maximum of five years at any time in the first year of ownership by visiting <http://www.meaco.com/proddetail.asp?prod=Extwarranty>. If you have trouble in using this link then go to www.meaco.com and you will find the extended warranty under Dehumidifiers.

TECHNICAL SPECIFICATIONS

Model	Meaco DD8L desiccant dehumidifier
Power consumption	30/330/650 watts
Power supply	220-240V / 50Hz
Dehumidifying capacity	8 litres / day
Capacity water container	2 litres
Air flow	80/100/115m ³ /h
For homes up to	Small 5 bedroom house
Operating range	1 – 37°C
Dimensions (w x d x h)	351 x 188 x 500mm
Net weight	6.4Kgs
Gross weight	7.4Kgs
Sound pressure level	39/43/48dB
Fuse rating	250V. F1.6A



This marking indicates that this product should not be disposed with other household wastes throughout the EU. To prevent possible harm to the environment or human health from uncontrolled waste disposal, recycle it responsibly to promote the sustainable reuse of material resources. To return your used device, please use the return and collection systems or contact the retailer where the product was purchased. They can take this product for environmental safe recycling.



CUSTOMER SERVICE

This dehumidifier has been imported into the U.K. by;

Meaco (U.K.) Limited

Meaco House

Parklands

Railton Road

Guildford

GU2 9JX

Telephone: 01483 234900/0500 418458

Email: customerservice@meaco.com

Website: www.meaco.com

Fax: 01483 232700

Please record, for future reference, your date of purchase and where you bought the dehumidifier from here.

Date of purchase.....

Purchased from www.meaco.com (if not then please record the supplier's name below).

.....

Meaco are specialists in dehumidifiers and would welcome your comments and questions on this dehumidifier. If you do develop a fault within the first year then please do call us and if we cannot fix the problem over the phone we will be happy to collect the dehumidifier from you at our expense and repair or replace as appropriate.

Please save the box just in case this happens.